

SpeedBox 3.1 B.Tuning for Ginat

STEP 1: Preparation for installation

- A.** Prepare the following tools:
1. Hex Key H8
 2. Hex Key H3
 3. Hex Key H2.5
 4. IHex Key H2
 5. T25 Torx screwdriver
- B.** Turn off the e-bike.
- C.** Remove the battery from the e-bike according to the manufacturer's manual.

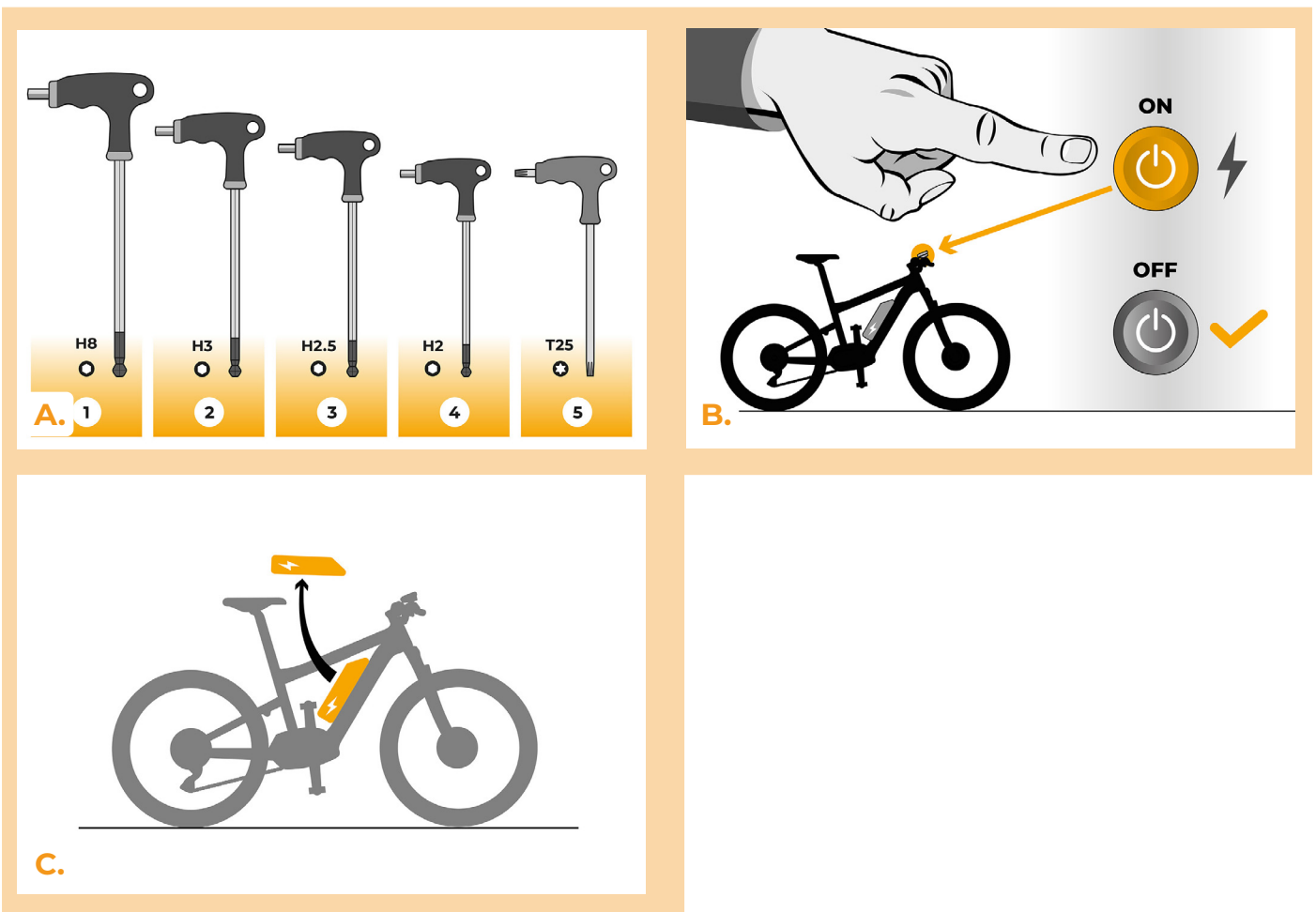

STEP 2: Crank removal

- A.** Remove the crank bolt of the left crank arm using the hex key H8. If the crank is not self-extracting, it is necessary to use a crank puller - please see the User manual on our website.
- B.** Remove the crank arm from the central axis of the motor.

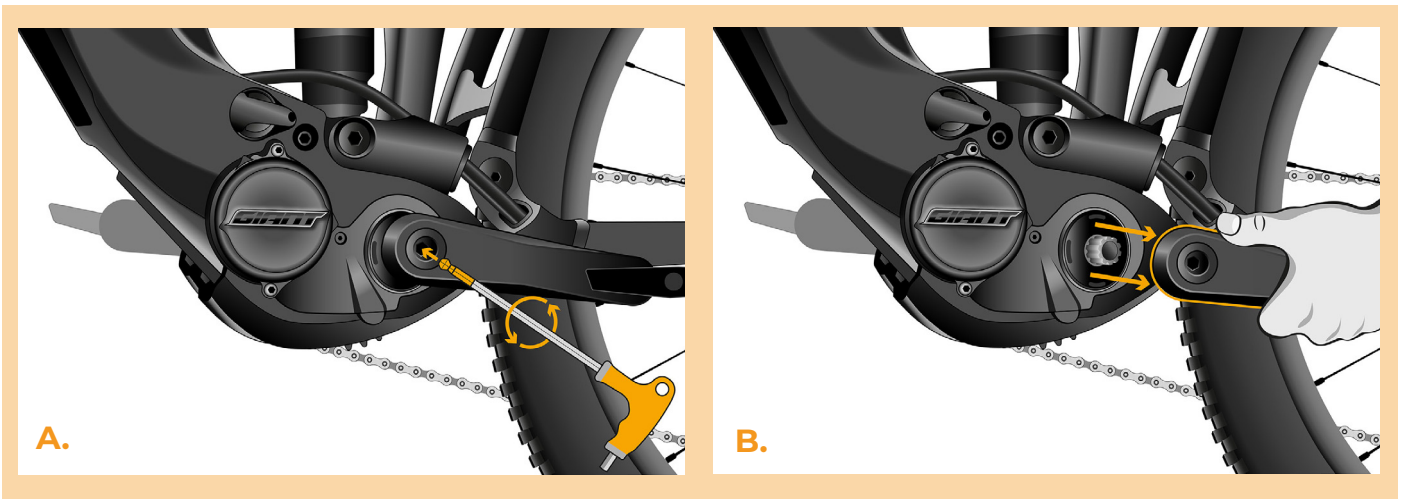

STEP 3: Motor cover removal

- A.** Unscrew the four screws holding the lower motor cover with the hex key H2.5.
- B.** Remove the motor cover.
- C.** Unscrew the three screws holding the side motor cover with the hex key H3, H2.5, H2.
- D.** Remove the side motor cover.

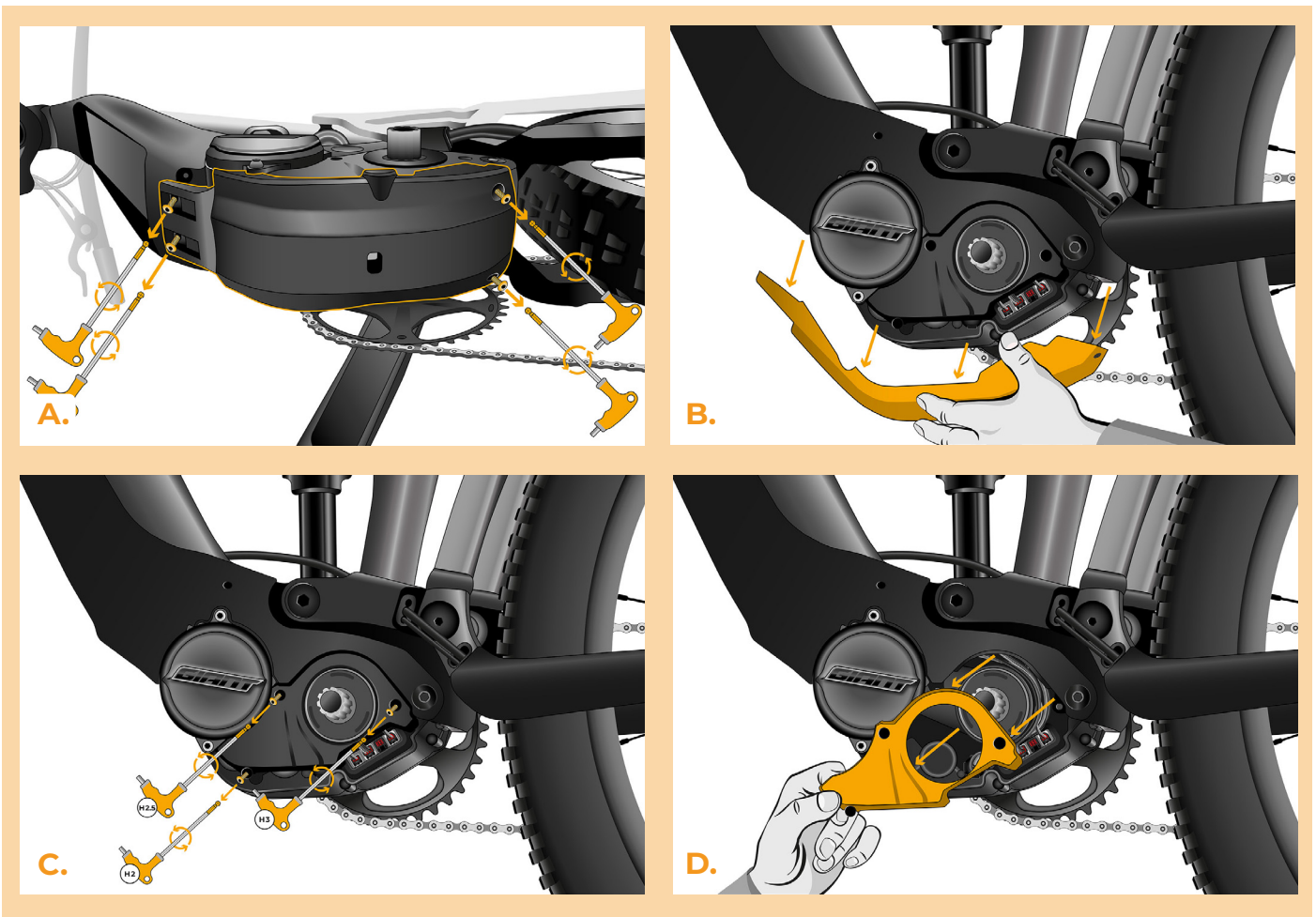

STEP 4: Disconnecting the connectors from the motor

- A. Disconnect the speed sensor connector.
- B. Disconnect the display connector in the same manner.

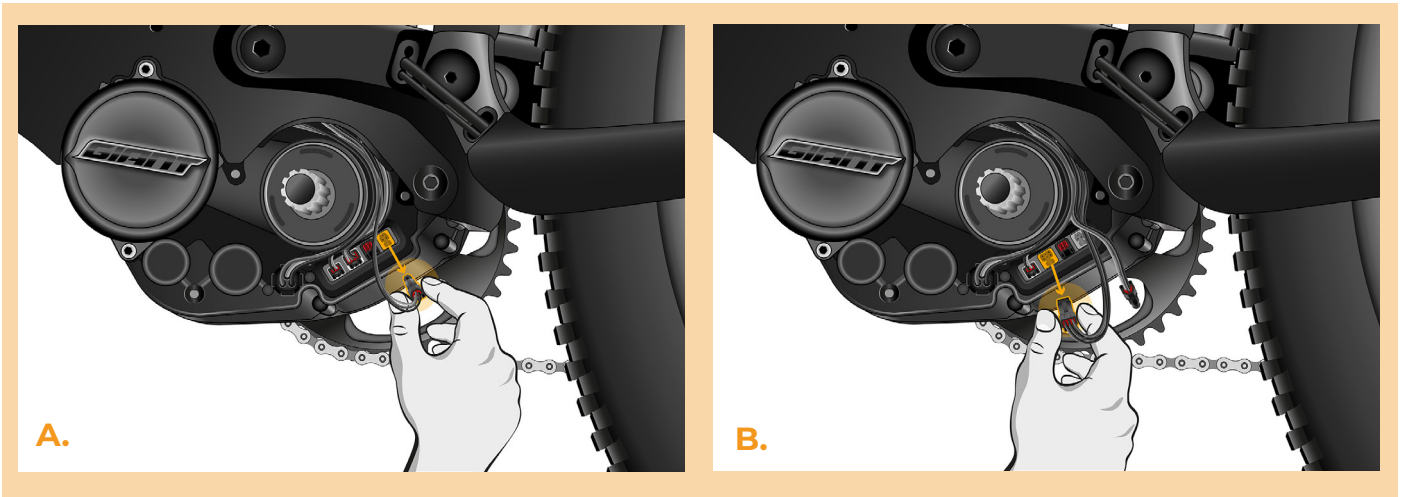

STEP 5: SpeedBox tuning installation

- A.** Plug SpeedBox into the disconnected connectors (step 4).
- B.** Make sure that the locks on the connectors are seated properly.
- C.** Před zakrytím motoru zkontrolujte správné zapojení podle obrázku.

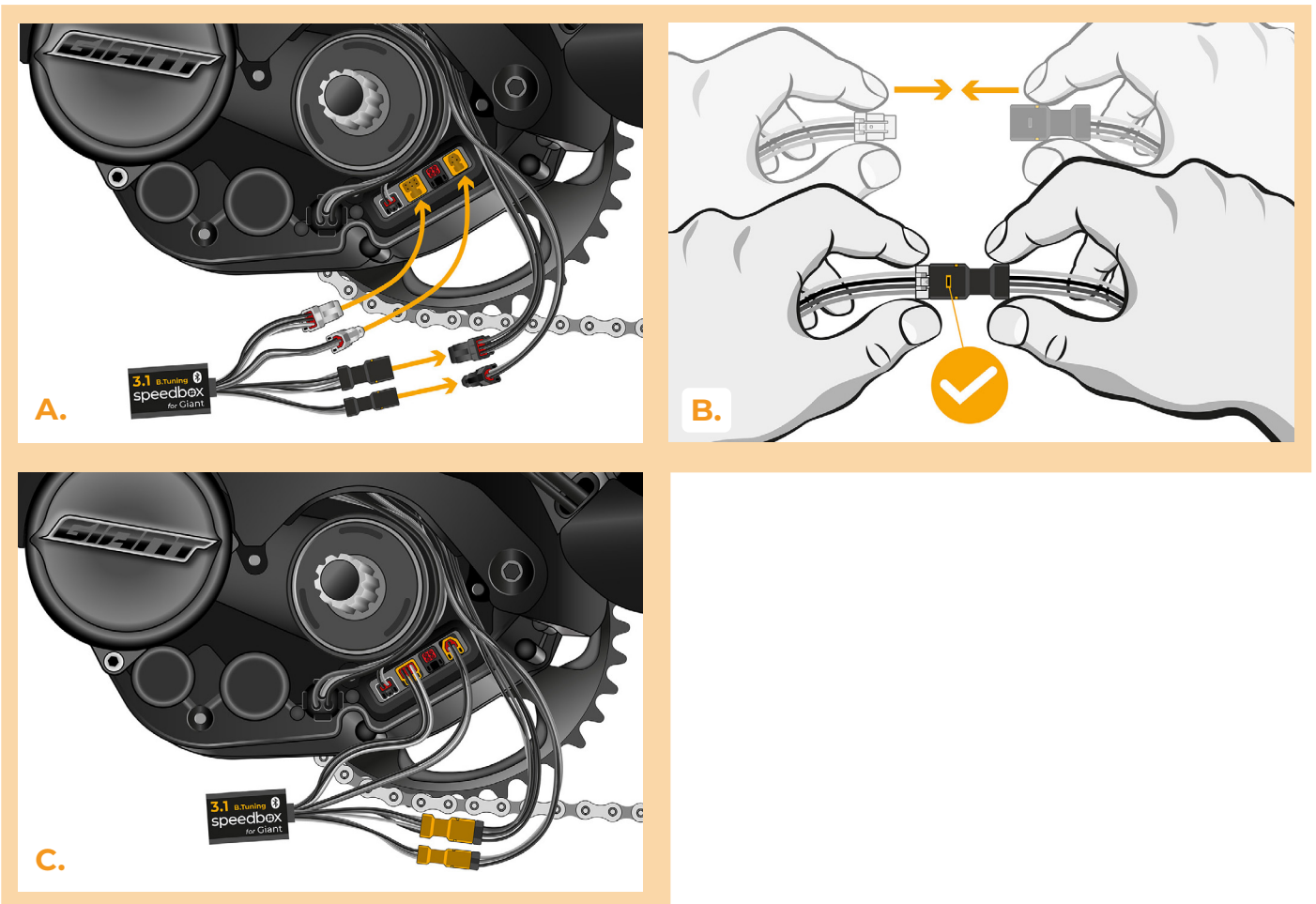

STEP 6: Motor cover assembly

- A.** Fit the SpeedBox and all connectors and wires leading from the motor into the free space under the side motor cover.
- B.** Put the side motor cover back (1.) and tighten the three screws with the hex key H3, H2.5, H2 (2.).
- C.** Put the lower motor cover back.
- D.** Attach the motor cover with 4 screws (H2.5).

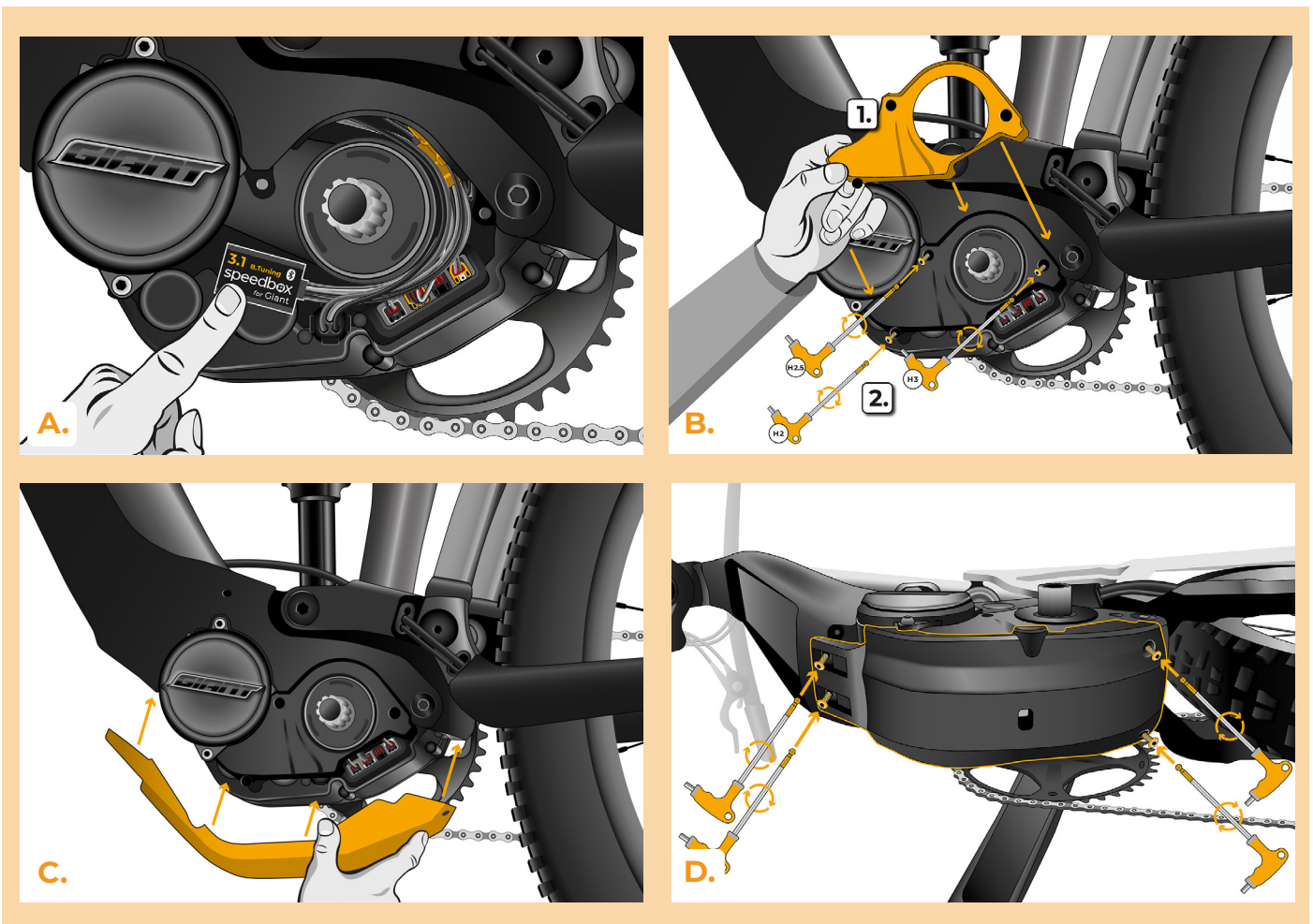

STEP 7: Motor cover assembly

- A. Put the crank arm back to the central axis of the e-bike motor.
- B. Screw the crank bolt into the crank arm and tighten it with the hex key H8.

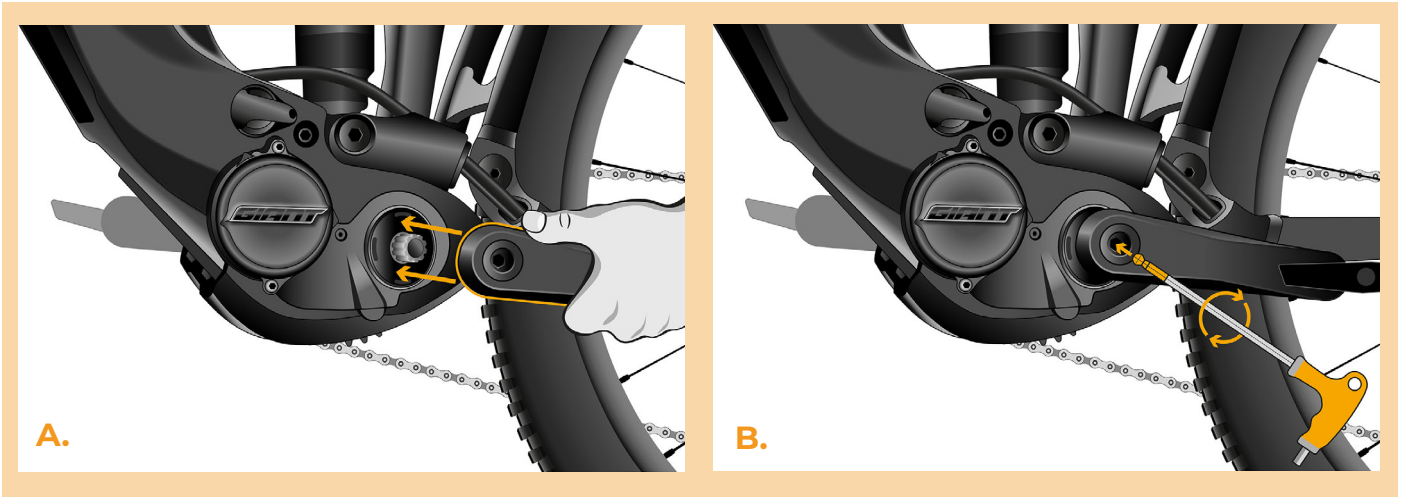

STEP 8: Tuning function check

- A.** Place the battery back into the e-bike.
- B.** Turn the e-bike on.
- C.** You will activate/deactivate tuning by brief activation of the WALK function or by switching between two assistance modes twice (+-+).
- D.** Spin the rear wheel and make sure the rear wheel speed is shown on the e-bike display.

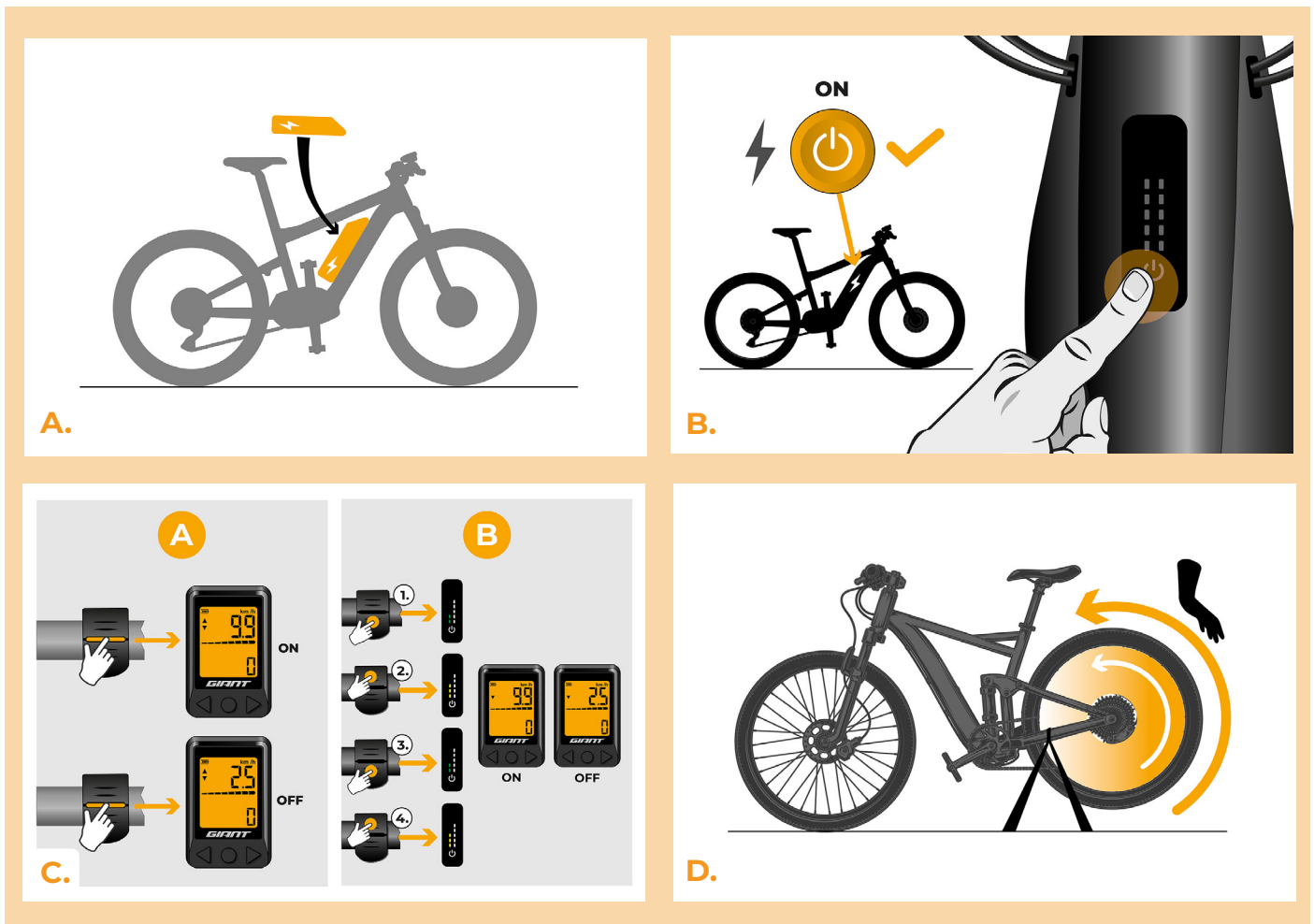

STEP 9: Setting the speed limit

- A.** To set the maximum speed limit, switch the modes: - - - + + +. The current speed limit will be displayed.
- B.** Set the maximum speed limit by pressing the WALK button briefly or by turning the rear wheel 360°. With each brief activation of the WALK function or turning of the wheel, the limit increases by 5 km/h. The last displayed limit is saved after five seconds of inactivity.

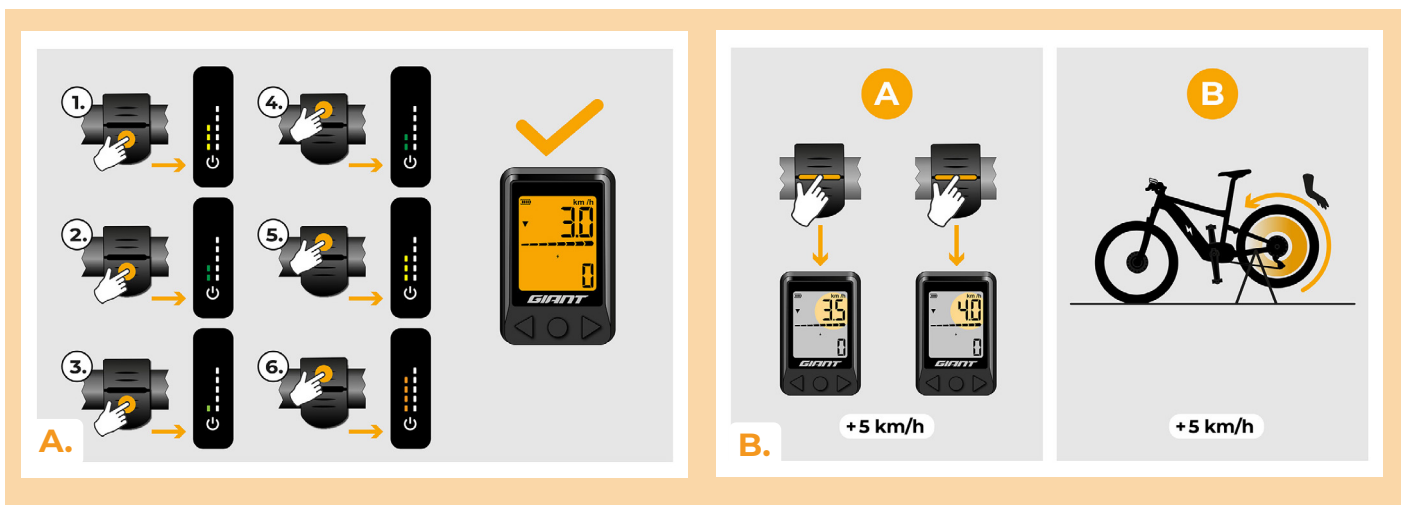

STEP 10: Pairing SpeedBox with the SpeedBox App

- A.** Install the SpeedBox App from Google Play or App Store.
- B.** Turn on Bluetooth on your phone.
- C.** Open the SpeedBox App. Enable location services if prompted.
- D.** Select the device MyEbike_XXXX. If you do not see it in the list, click on the “Refresh” button and, if necessary, make sure that:
 1. Your e-bike is switched on.
 2. You are not further than 5 m from your e-bike.
 3. You have Bluetooth turned on on your mobile phone.
 4. You have enabled location services for the SpeedBox App.
- E.** Choose and confirm your PIN and service password.
- F.** Now you can fully enjoy the SpeedBox App (control tuning, monitor riding data, and information about motor performance and energy consumption, you can set the speed limit, etc.).

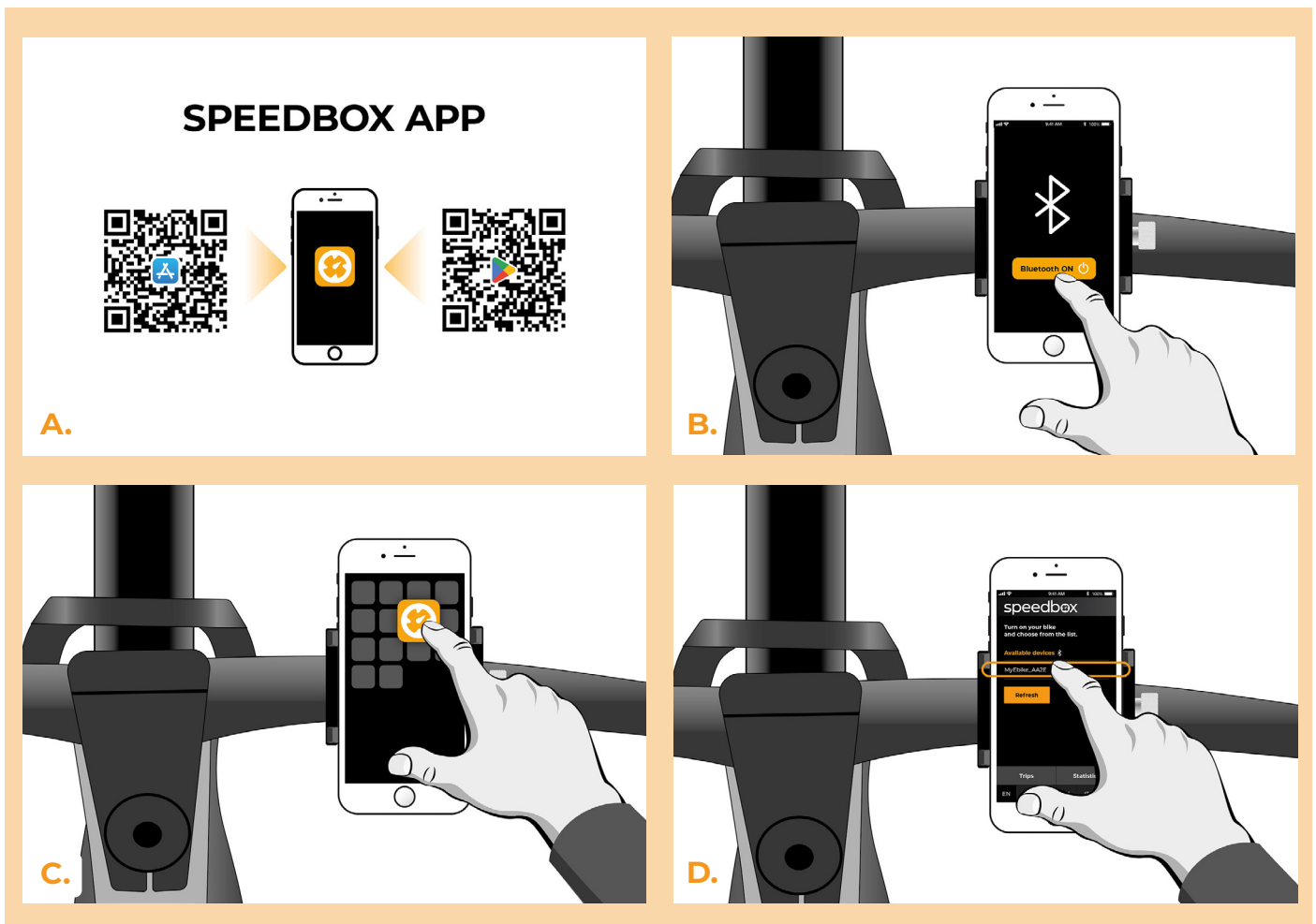

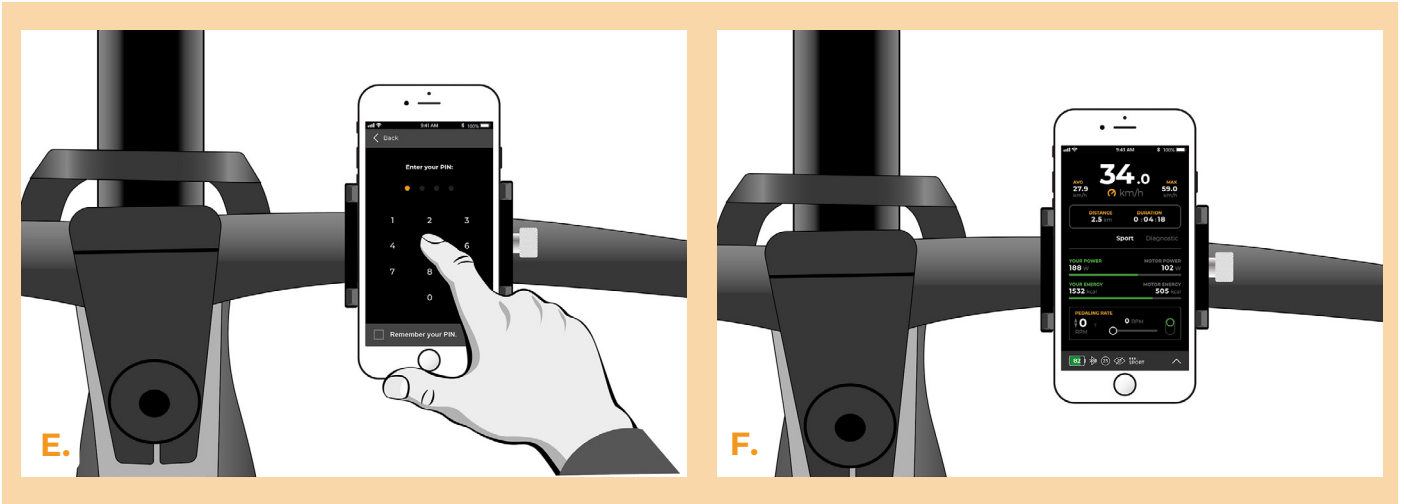

www.speedbox-tuning.com

Ebike Electronic s.r.o.

Rybna 716/24 | 110 00 Praha 1 | Czech Republic | ID: 05553555 | VAT: CZ05553555

