

SpeedBox 1.1 for Bosch (Smart System)

STEP 1: Preparation for installation

- A. Prepare the following tools: Hex Key H4 (*tools may vary depending on the type of e-bike*).
- B. Turn off the e-bike.
- C. Remove the battery from the e-bike according to the manufacturer's manual.

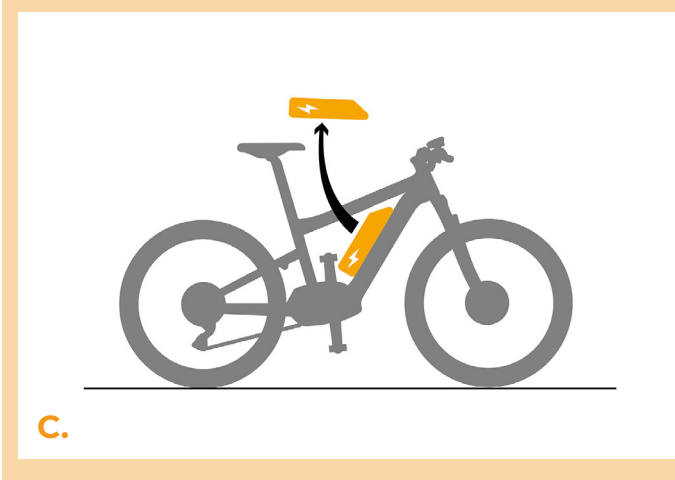
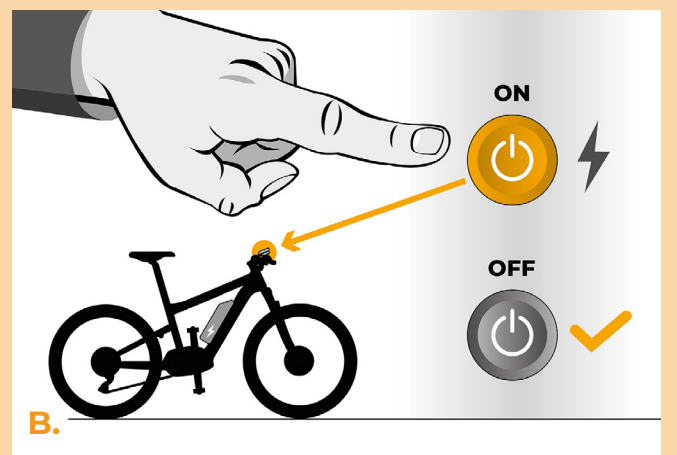
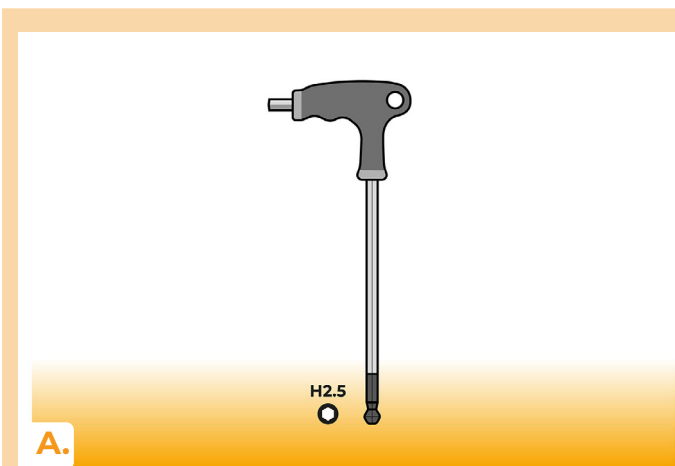

STEP 2: Motor cover removal

- A. Unscrew the screw holding the motor cover with the hex key H4.
- B. Remove the motor cover.

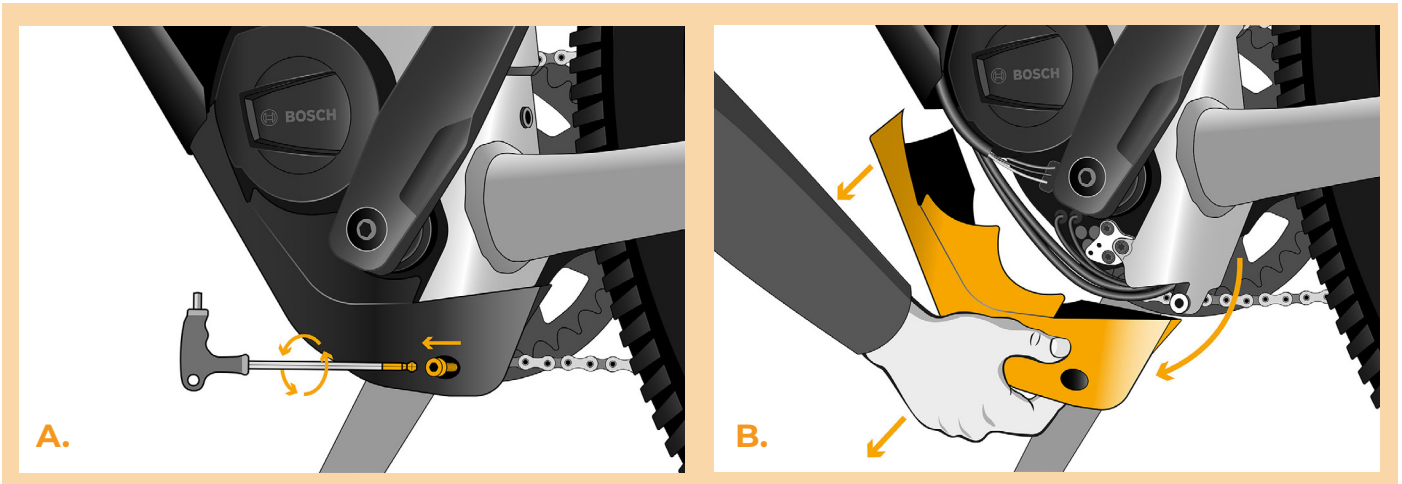

STEP 3: Disconnecting the connectors from the motor

- A. Disconnect the speed sensor connector.
- B. Disconnect the display connector in the same manner.

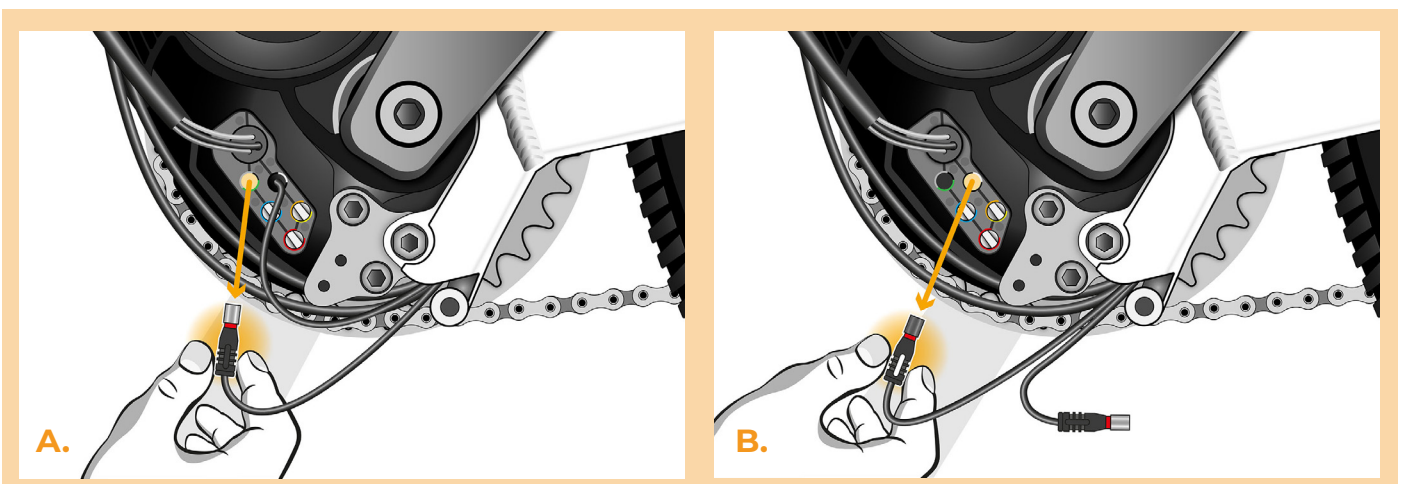

STEP 4: SpeedBox tuning installation

- A.** Replace the original connectors with the SpeedBox connectors.
- B.** Plug the e-bike connectors, disconnected from the motor (step 3), into the SpeedBox connectors. Make sure that the locks on the connectors are seated properly.
- C.** Before assembling the motor, check the correct wiring as shown in the figure.

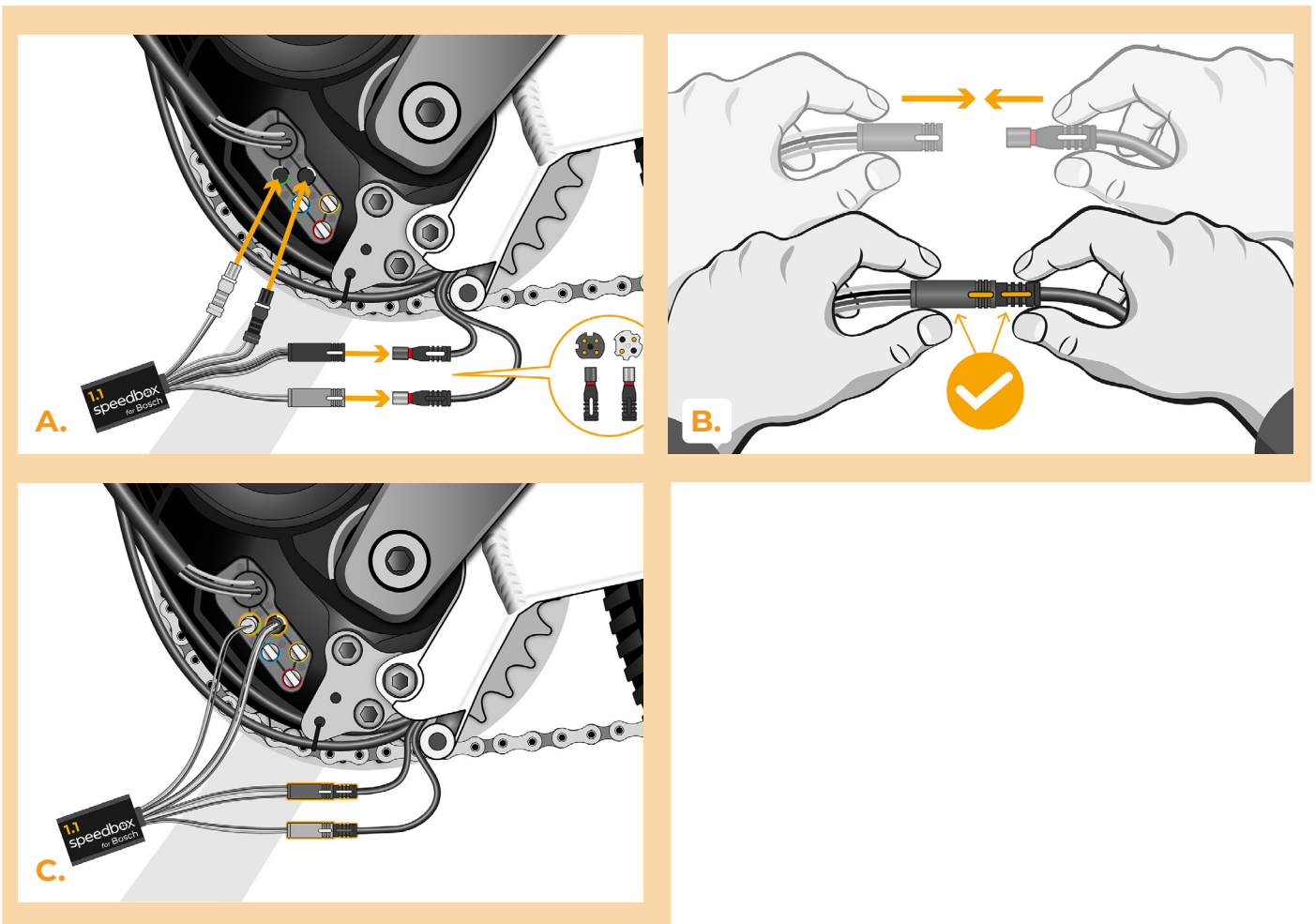

STEP 5: Motor cover assembly

- A.** Fit the SpeedBox and all connectors and wires leading from the motor into the free space in the motor.
- B.** Place the motor cover back to its original position.
- C.** Reattach the motor cover by tightening the screw with the hex key H4.

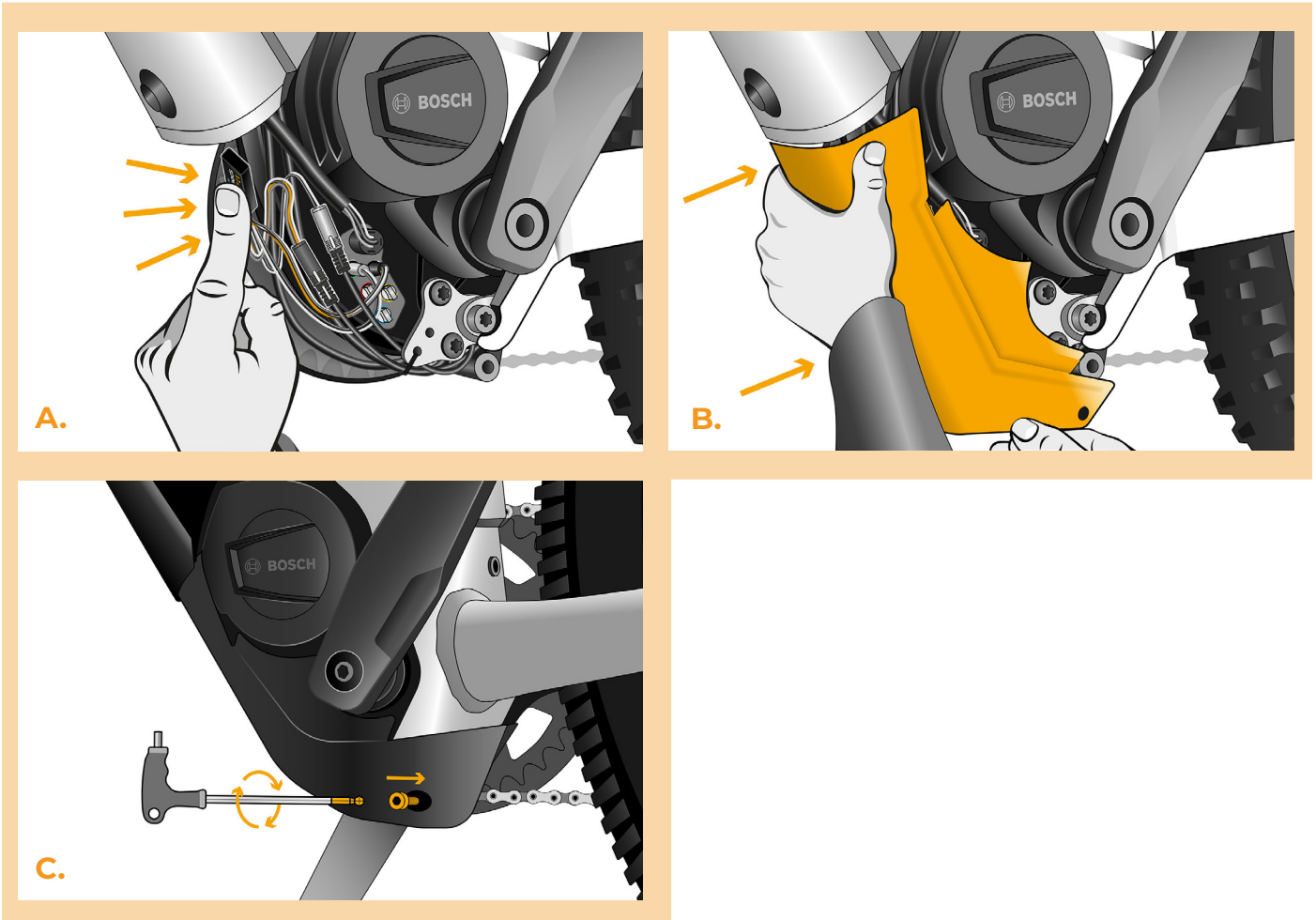

STEP 6: Tuning function check

- Place the battery back into the e-bike.
- Turn the e-bike on.
- Before the first ride with SpeedBox installed, it is necessary to enter the menu and check the wheel circumference: "Settings" > "My Bike" > "Wheel circumference". Then return to the home screen.
- Activate/deactivate tuning by brief activation of the WALK function or by switching between two assistance modes twice (+--+). The value of 3.5 or 2.5 indicating the maximum speed in km/h will be displayed.
- Spin the rear wheel and make sure the rear wheel speed is shown on the e-bike display.

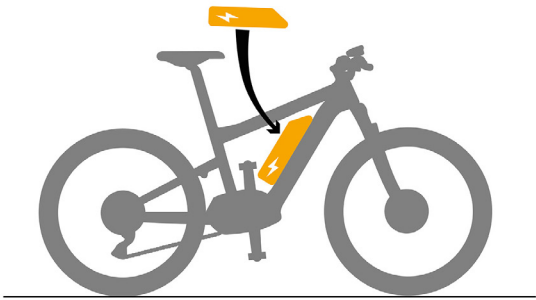

A.

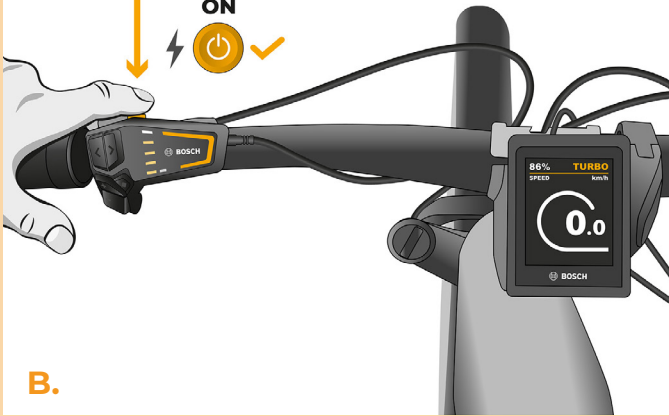

B.



C.

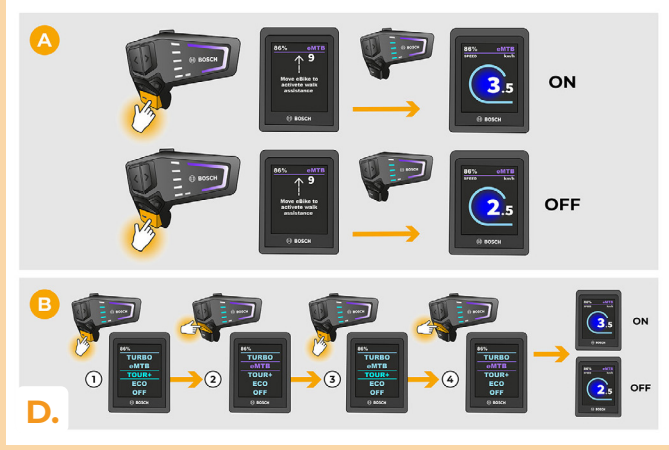

D.



E.

STEP 7: Setting the speed limit

- A.** You can set the maximum speed limit by switching the modes: TURBO - eMTB - TOUR+ - ECO - TOUR+ - eMTB - TURBO. An actual speed limit will be displayed after that.
- B.** The maximum speed of an electric assistance can be changed by activating/deactivating the WALK assist function (in this case by pressing „-“ and „+“) or by turning the rear wheel 360°.
- C.** To avoid tuning detection on your e-bike, after finishing your ride, leave the e-bike switched on until a speed of 0.0 km/h is permanently shown on the display.

A. Sequence of mode switches: TURBO - eMTB - TOUR+ - ECO - TOUR+ - eMTB - TURBO. Final display: 86% TURBO, DISTANCE 1.9, RIDING TIME 11:36, SPEED 3.5.

B. Adjusting speed limit: Pressing "-" and "+" buttons or turning the rear wheel 360°. Result: +5 km/h, final speed limit 4.0 km/h.

C. Final steps: **STEP 1** shows display with 0.0 km/h. **STEP 2** shows speedbox turned OFF.



www.speedbox-tuning.com

Ebike Electronic s.r.o.

Rybna 716/24 | 110 00 Praha 1 | Czech Republic | ID: 05553555 | VAT: CZ05553555

